

● Before operating the switching power supply, read this instruction sheet and keep it for future reference.

1. Safety Standard Conditions

Applicable standards: UL508 Listed, UL1310 Class 2 (PS5R-SC, -SD only)
 UL1604, CSA C22.2 No.14, EN60950, EN50178

EMC: EN61204-3

2. Type No. Guide

PS5R-S□□
 ① Wattage Code ② Output Voltage Code
 C: 30W 12: 12V (PS5R-SC only)
 D: 60W 24: 24V
 E: 90W
 F: 120W
 G: 240W

3. Conditions

Operating temperature: -10 to +60°C
 (without freezing, see output derating)
 Storage temperature: -25 to +75°C (without freezing)
 Operating/storage humidity: 20 to 90% RH (without condensation)
 Altitude: Up to 2000m above sea level
 Pollution degree: 2

4. Rating

Use the switching power supply with the output wattage within the values shown below.
 Leakage current: 0.75 mA max. (PS5R-SC, -SD, -SE)
 1.0mA max. (PS5R-SF, -SG)

Code	Input Voltage V AC	Input Current A	Input Frequency Hz	Output Voltage V DC	Output Current Max. A	Output Wattage Max. W
12	100-240	0.9	50-60	10.8-13.2	2.5	30
24	100-240	0.9	50-60	21.6-26.4	1.3	31.2

Code	Input Voltage V AC	Input Current A	Input Frequency Hz	Output Voltage V DC	Output Current Max. A	Output Wattage Max. W
24	100-240	1.7	50-60	21.6-26.4	2.5	60

Code	Input Voltage V AC	Input Current A	Input Frequency Hz	Output Voltage V DC	Output Current Max. A	Output Wattage Max. W
24	100-240	2.3	50-60	21.6-26.4	3.75	90

Code	Input Voltage V AC	Input Current A	Input Frequency Hz	Output Voltage V DC	Output Current Max. A	Output Wattage Max. W
24	100-240	1.8	50-60	21.6-26.4	5.0	120

Code	Input Voltage V AC	Input Current A	Input Frequency Hz	Output Voltage V DC	Output Current Max. A	Output Wattage Max. W
24	100-240	3.5	50-60	21.6-26.4	10.0	240

5. Output Derating

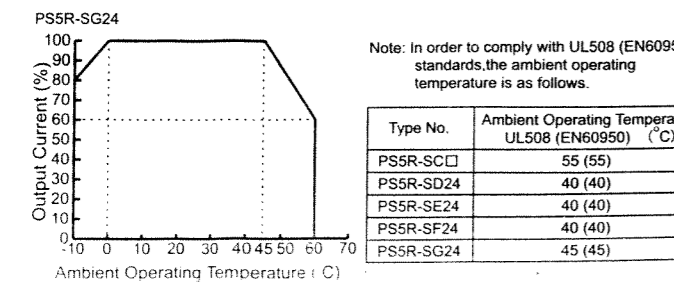
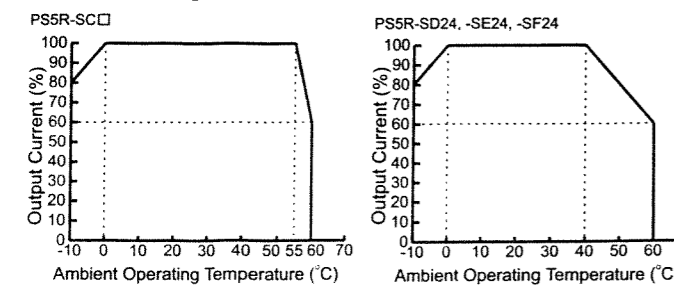

6. Terminal Marking and Description

- (L) AC Input Terminal
 - (N) AC Input Terminal
 - (G) Ground Terminal (Protective earthing terminal)
 - (-) DC Output Terminal
 - (+) DC Output Terminal
 - (VR.ADJ) Output Voltage Adjustment
 - (DC ON) Operation Indicator
 - (DC LOW) Output Low Indicator
- ※When the AC input is turned on or off, the LED turns on temporarily, causing no problem.

PS5R-SC□, SD24

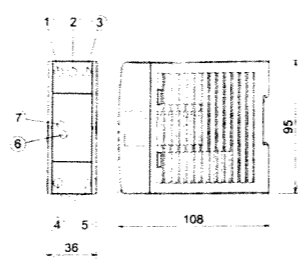

PS5R-SE24

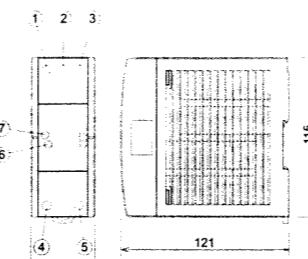

PS5R-SF24

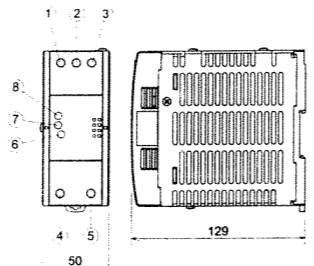

PS5R-SG24

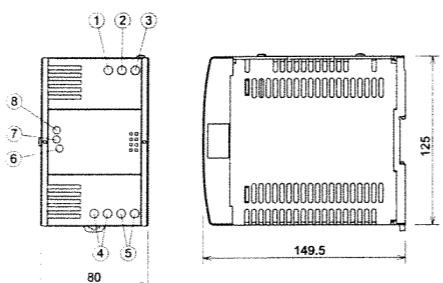

7. Power Supply Installation

- Make sure of sufficient convection in consideration of heat radiation. Do not block the opening of the switching power supply.
- Keep at least 20mm clearance around the switching power supply, except for the opening.
- When the derating is in question, provide forced air-cooling.
- Connect ground terminal to a proper ground completely.
- Use minimum 60°C wire, copper wire only. Recommended wire type: AWG18 to 14 (Cross section 0.75 to 2.0 mm²).
- Terminal tightening torque 0.8 N·m.
- Adjusting the Output Voltage
The output voltage can be adjusted within ±10% of the rated output voltage using the VR.ADJ (output voltage adjustment). Note that the overvoltage protection may work when the output voltage is raised.
- Overcurrent Protection
When an overcurrent flows due to an overload, the output voltage drops. When the load is reduced to a normal level, the normal output voltage is restored. Note that an overload or short-circuit condition continuing for an extended period of time will deteriorate or damage internal elements.
- Overvoltage Protection
The PS5R-S uses a manual reset method after power shutdown. To recover from output voltage drop due to an overvoltage, turn off the AC input, and turn on the AC input after approximately 1 minute.
- Series Operation
Two PS5R-S switching power supplies can be connected in series. When connecting the switching power supplies in series, insert a Schottky diode in the output line of each switching power supply. (UL1310 Class 2 does not allow series connection.)
- Parallel Operation
The PS5R-S cannot be connected in parallel. If connected in parallel, internal elements and loads may be damaged.

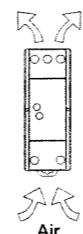

8. Mounting

Allowable mounting direction is A only.

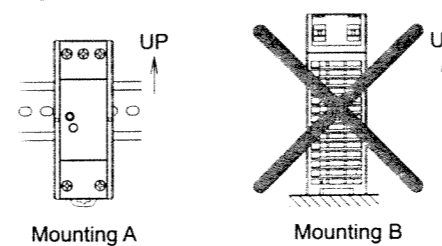

<Mounting on 35mm-wide DIN Rail>

- Fasten the DIN rail to a panel firmly.
- Put the groove of the switching power supply on the DIN rail, with the input terminal side up, press the switching power supply to the panel.
- Use BNL6 mounting clips on both the sides of the switching power supply to prevent from moving sideways.

<Removing from DIN Rail>

Insert a flat screw driver into the slot in the clamp. Pull the clamp out until the clamp clicks, and turn the switching power supply bottom out.

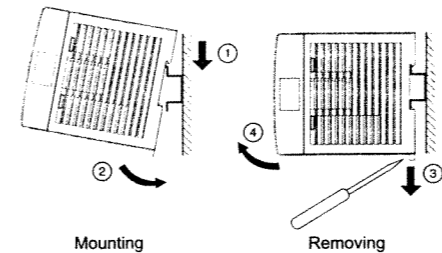

Mounting Bracket (Option)

Mounting holes layout is shown below.

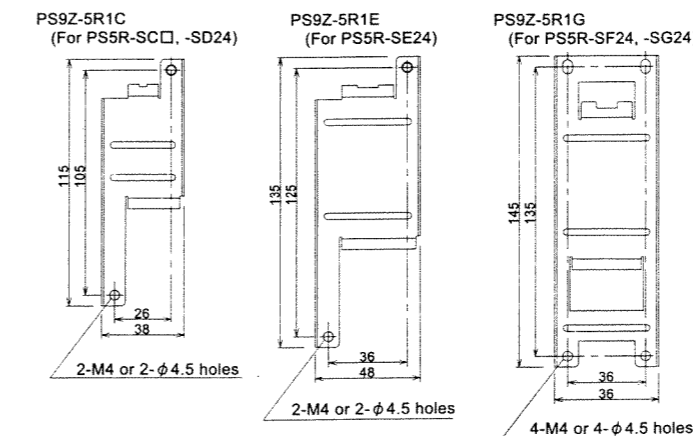

Installing the Mounting Bracket (Option)

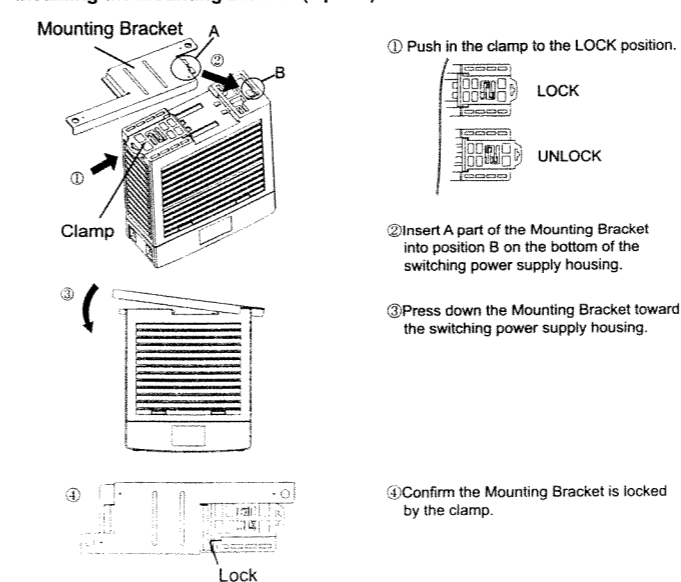

SAFETY PRECAUTIONS

This equipment is suitable for use in Class I, Division 2, Groups A, B, C, I or Non-hazardous Location Only.
 Warning - Explosion Hazard - Substitution of components may impair suitability for Class I, division 2.
 Warning - Explosion Hazard - Do not disconnect equipment unless power has been switched off or the area is known to be non-hazardous.

- Read the following safety precautions to make sure of correct operation before starting installation, wiring, and operation.
- In this instruction sheet, safety precautions are categorized in order of importance to Warning and Caution:

WARNING ...Warning notices are used to emphasize that improper operation may cause severe personal injury or death.

- Do not use the switching power supply on control equipment in aircraft, trains, and atomic equipment where malfunction of the switching power supply may cause severe personal injury or threaten human life. These switching power supplies are designed for use on general electronic equipment such as office equipment, communication equipment, instrumentation equipment, and industrial control equipment.
- Make sure that the operating conditions satisfy the values described in the catalog. Confirm the specification values before designing the equipment to use the switching power supply and before supplying power. Contact IDEC if you have any question.
- Do not modify or repair the switching power supply. Modification or repairing of the switching power supply by users may cause electrical shocks, damage, fire, malfunction, and other heavy accidents.
- Do not install the switching power supply where a human body may come into contact while power is supplied to the switching power supply. Do not touch the switching power supply during operation or immediately after turning off because some parts are heated and at a high voltage, causing burns or electrical shocks. The PS5R-S switching power supplies are designed for installation in a cabinet.
- Do not connect the output terminals or output lead wires together. Fire or damage may result.
- Include a protection in the equipment using the switching power supply in consideration of malfunction or damage of the load in case the switching power supply should fail. If the switching power supply should fail, a very high voltage drop may occur at the output terminals.
- Turn power off before wiring the switching power supply. Make sure of correct wiring. Incorrect wiring may cause electrical shocks or damage.

CAUTION ...Caution notices are used where inattention might cause personal injury or damage to equipment.

- Make sure of the correct input voltage. Incorrect input voltage may cause blown fuses, fuming, or fire. Make sure of correct polarity of input and output terminals before supplying power to the switching power supply.
- Do not touch any part inside the switching power supply. Prevent foreign objects from entering into the housing of the switching power supply. If the internal parts are touched by hand or foreign objects such as a paper clip or screw entering into the housing, accidents or damage may occur.
- Observe the temperature derating. The operating temperature is the temperature around the switching power supply. Use the switching power supply within the temperature derating curve. Otherwise, the internal temperature will rise and damage may be caused.
- When damage or malfunction should occur during operation, immediately turn power off and stop the switching power supply. Contact IDEC.
- Do not use or store the switching power supply in environments subjected to a large amount of vibrations or shocks. Otherwise, damage may be caused.
- Do not install the switching power supply in environments exposed to direct sunlight, iron particles, oil splashes, chemicals, and hydrogen sulfide. Do not use the switching power supply in humid places such as basements or greenhouses or in low-temperature places such as in freezers or in front of cooler outlet.