

Part number

# MKAX IAP20



## Brief description:

angled bulkhead housings with single lever, size "21.21", with threaded entry, M20, metal version, IP44, IP66/IP67 degree of protection with CKR 65 kit or CKR 65 D kit.

### Product description

<b>Version</b>	Metallic type
<b>Series</b>	Angled mounting housings with 1 lever
<b>Product type</b>	with stainless steel lever
<b>Variant</b>	with threaded entry
<b>Family</b>	CKA metal enclosures
<b>Size</b>	size "21.21"

### Technical data

<b>Operating temperature range (min, max)</b>	-40°C ... +125°C
<b>Material</b>	metal
<b>IP degree of protection</b>	IP44 (IP66/IP67 with CKR 65/CKR 65 D kits)
<b>Cable entry</b>	M20

### Further technical details

<b>Weight</b>	37,00 g
---------------	---------

### Approvals / Standards

<b>Quality mark</b>	UL type: 12, (type 4/4X only with kit CKR 65 or CKR 65 D),  , EAC
<b>Conformity</b>	CQC, CE

### General ordering information

<b>EAN13 code</b>	8015747056908
<b>Tariff number</b>	85369095

### Packaging Information

<b>Sub-packaging length</b>	140,00 mm
<b>Sub-packaging height</b>	66,00 mm
<b>Sub-packaging width</b>	150,00 mm
<b>Sub-packaging weight</b>	0,37 kg
<b>Sub-packaging volume</b>	1,39 dm <sup>3</sup>
<b>Sub-packaging description</b>	Carton Box
<b>Sub-packaging quantity</b>	10 Pcs
<b>Sub-packaging EAN barcode</b>	8015747056915

Part number

# MKAX IAP20



Catalogue drawings

Catalogue drawings

CKA IA

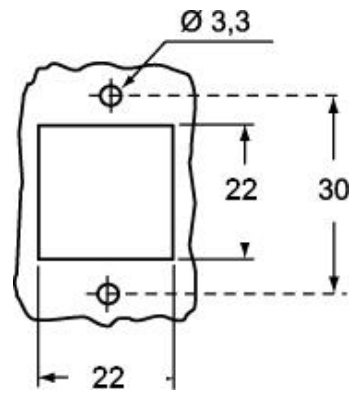
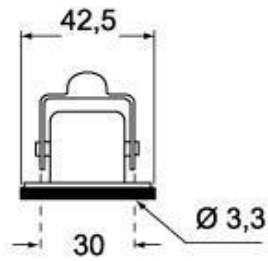
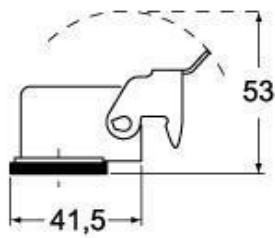

CKAX IA

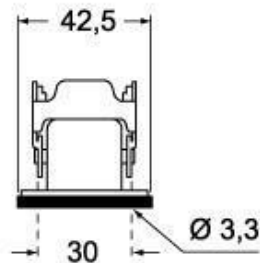
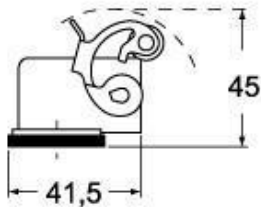

CKA IAPS (CKA APS) MKA - IAP (MKA AP)

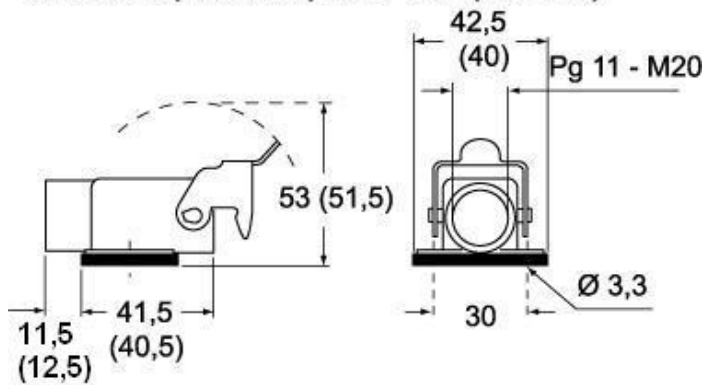

CKAX IAPS (CKAX APS) - MKAX IAP (MKAX AP)

