

# KBWC

## Wall-Mount Series

### Solid-State

### Variable Speed AC Motor Controls

**For Use with Shaded Pole,  
Permanent Split Capacitor (PSC)  
and Universal Motors**

Ratings: 2.5 thru 15.0 Amps  
115 and 230 VAC – 50/60 Hz

#### TYPICAL APPLICATIONS

- Fans • Fireplace Blowers • Humidifiers • Air Conditioners
- Ceiling Fans • Attic Fans
- Ventilators • Range Hoods

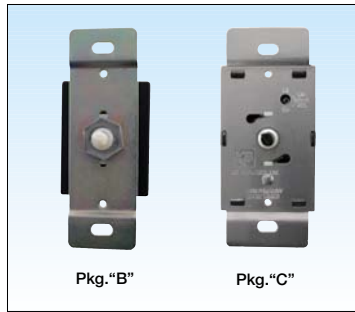

Pkg. "B"

Pkg. "C"



Dial Plate & Knob Pkgs. "B" & "C"



Pkg. "E"



Pkg. "D"

#### STANDARD FEATURES

- Built-In On/Off AC Line Switch
- Minimum Speed Trimpot
- RFI Filter (Provides RFI and EMI Suppression)
- All Models Mount in a Standard 2" x 4" Electrical Wall Box
- Agency Approvals\*
  - UL Listing / Recognition
  - CSA Certified
  - ISO-9001: 2000 QMS Certified

#### OPTIONAL FEATURES (See Options Table)

- Custom Packaging
- Special Lead Lengths, Colors, and Terminations

#### DESCRIPTION

The KBWC Series is a comprehensive line of motor speed controls for air-moving applications that utilize Shaded Pole, Permanent Split Capacitor (PSC), and AC/DC motors. These economical speed controls are designed to replace obsolete, tapped winding, or reactive methods of speed control. The full-wave phase control circuitry minimizes power loss, thereby reducing energy requirements. The controls provide infinitely variable speed adjustment which allows the end-user to select the desired level of air volume. These models cover a wide range of current ratings (2.5 - 15 Amps AC) and voltage ratings (115, 230, 277 Volts AC).



Important features, such as RFI Filter, Minimum Speed Trimpot, and built-in On/Off Line Switch are standard. These speed controls are available as bulk packaged or in distributor type packaging with accessories such as: knob, dial plate, mounting hardware, instructions, and individual carton. All models are designed to be mounted into a standard 2" X 4" electrical wall box.

#### OPTIONS (Add Suffix to Model No.)

| Suffix | Description  | Example      |
|--------|--|--------------|
| C      | Omits mounting tabs (KBWC-16 only).  | KBWC-16C     |
| F      | Adds Built-In Fuse (not available for Model KBWC-23NS).  | KBWC-15F     |
| K      | Mounting Kit: Includes individual packaging with dial plate, knob, mounting screws, wire connectors, and instructions. Supplied standard on all models rated 8 Amps and above. | KBWC-15K     |
| L      | Adds auxiliary lead (3-wire control).  | KBWC-15L     |
| 4L     | Adds DPDT On/Off Switch (4-wire control) (Model KBWC-25 only).   | KBWC-25 (4L) |
| NS     | Omits On/Off Switch.   | KBWC-15NS    |
| R      | Reverses control output from standard rotation. Standard: Controls with On/Off Switch – Off to High to Low. Controls without On/Off Switch (suffix "NS") – Low to High.        | KBWC-15R     |

**Note:** \*See Electrical Ratings table for agency approvals by Model No.

**ELECTRICAL RATINGS AND AGENCY APPROVALS**

| Model No.              | AC Line Input Voltage<br>(Volts AC – 50/60 Hz) | Maximum Current Rating<br>(Amps RMS) | Ambient Temperature<br>(°C) | Agency Approvals  |   |   | Package Type |
|------------------------|--|--------------------------------------|-----------------------------|---|---|---|--------------|
|                        |  |                                      |                             |  |  |  |              |
| KBWC-13                | 115  | 2.5                                  | 25                          | ✓   |   | ✓   | B            |
| KBWC-15                | 115  | 5                                    | 40                          |   | ✓   | ✓   | C            |
| KBWC-16                | 115  | 6                                    | 25                          | ✓   |   |   | C            |
| KBWC-18K <sup>1</sup>  | 115  | 8                                    | 40                          |   | ✓   | ✓   | D            |
| KBWC-110K <sup>1</sup> | 115  | 10                                   | 25                          | ✓   |   | ✓   | D            |
| KBWC-110K <sup>1</sup> | 115  | 10                                   | 40                          |   | ✓   | ✓   | E            |
| KBWC-112K <sup>1</sup> | 115  | 12                                   | 40                          |   |   |   | E            |
| KBWC-115K <sup>1</sup> | 115  | 15                                   | 25                          | ✓   |   |   | E            |
| KBWC-23 <sup>2</sup>   | 230  | 2.5                                  | 25                          | ✓   |   |   | B            |
| KBWC-25 <sup>3</sup>   | 230  | 5                                    | 40                          | ✓   |   |   | C            |
| KBWC-26                | 230  | 6                                    | 25                          |   |   |   | C            |
| KBWC-28K <sup>1</sup>  | 230  | 8                                    | 40                          |   |   | ✓   | D            |
| KBWC-210K <sup>1</sup> | 230  | 10                                   | 40                          |   |   |   | E            |
| KBWC-212K <sup>1</sup> | 230  | 12                                   | 40                          |   |   |   | E            |
| KBWC-215K <sup>1</sup> | 230  | 15                                   | 25                          |   |   |   | E            |
| KBWC-35                | 277  | 5                                    | 25                          | ✓   |   |   | C            |
| KBWC-36                | 277  | 6                                    | 25                          |   |   |   | C            |
| KBWC-38K <sup>1</sup>  | 277  | 8                                    | 25                          |   |   |   | D            |
| KBWC-310K <sup>1</sup> | 277  | 10                                   | 25                          |   |   |   | D            |
| KBWC-312K <sup>1</sup> | 277  | 12                                   | 25                          |   |   |   | E            |
| KBWC-315K <sup>1</sup> | 277  | 15                                   | 25                          |   |   |   | E            |

Notes: 1. Models rated 8 Amps and above include Mounting Kit (suffix "K"). 2. Only model containing suffix "NS" is UL Recognized. 3. Only Model KBWC-25 (4L) is UL Recognized. 4. The maximum Locked Rotor current for UL listed controls is 6 times the Maximum Current Rating.

**CONNECTION DIAGRAMS**

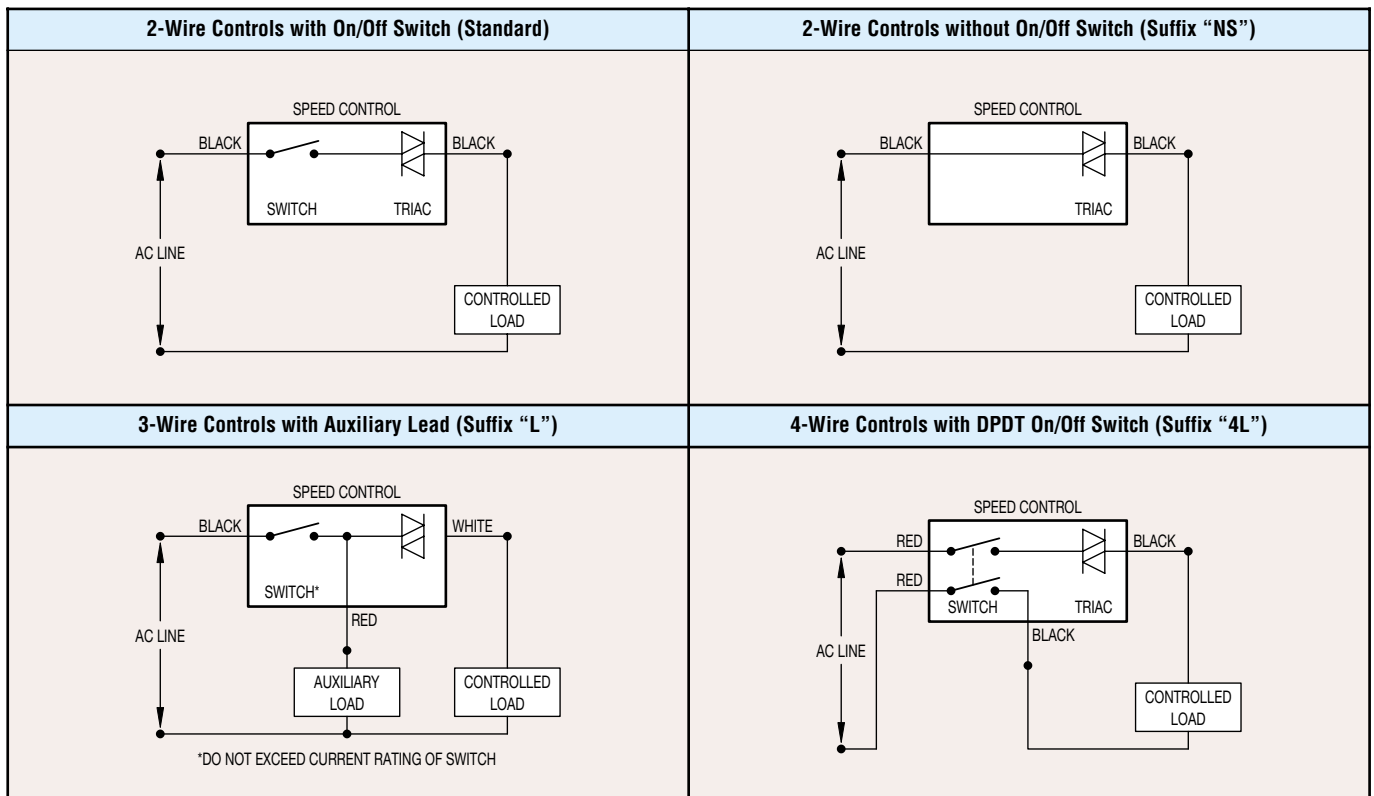

**KBWC-13, 23 (Pkg. B)**  
**Mechanical Specifications (Inches/mm)**

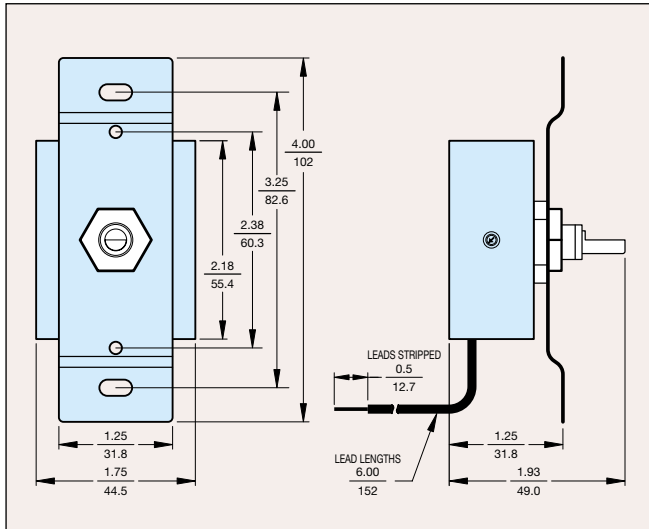

**KBWC-15, 16, 25, 26, 35, 36 (Pkg. C)**  
**Mechanical Specifications (Inches/mm)**

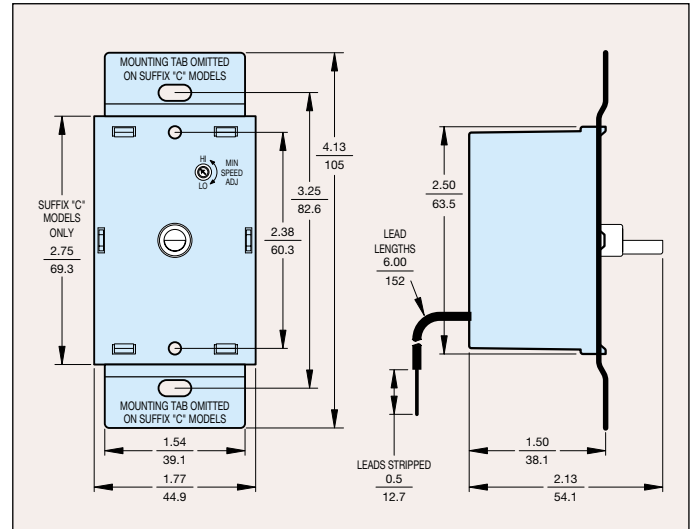

**Dial Plate and Knob Kit (Suffix "K")**  
**Mechanical Specifications (Inches/mm)**

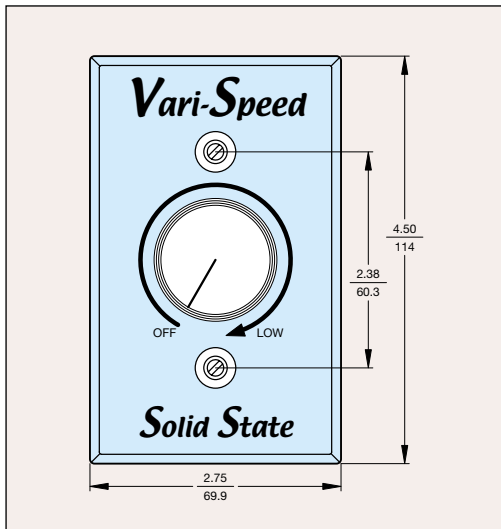

**KBWC-18K, 110K, 28K, 38K, 310K (Pkg. D)**  
**Mechanical Specifications (Inches/mm)**

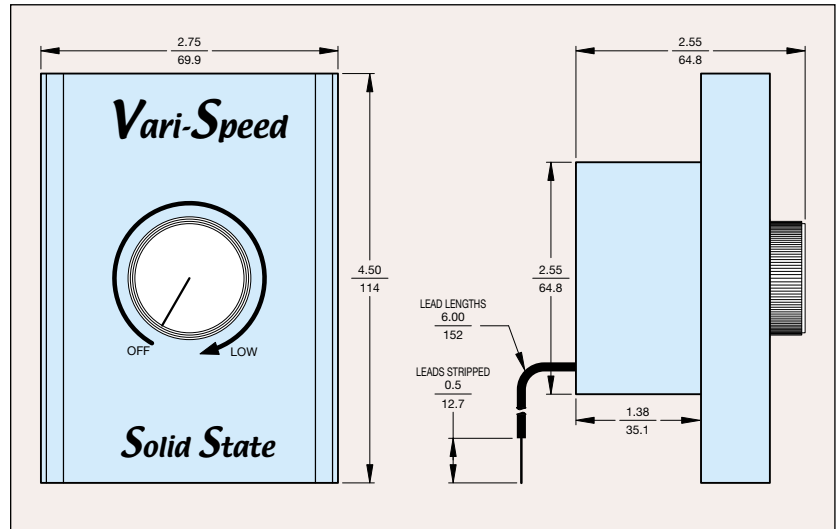

**KBWC-110K, 112K, 115K, 210K, 212K, 215K, 312K, 315K, (Pkg. E)**  
**Mechanical Specifications (Inches/mm)**

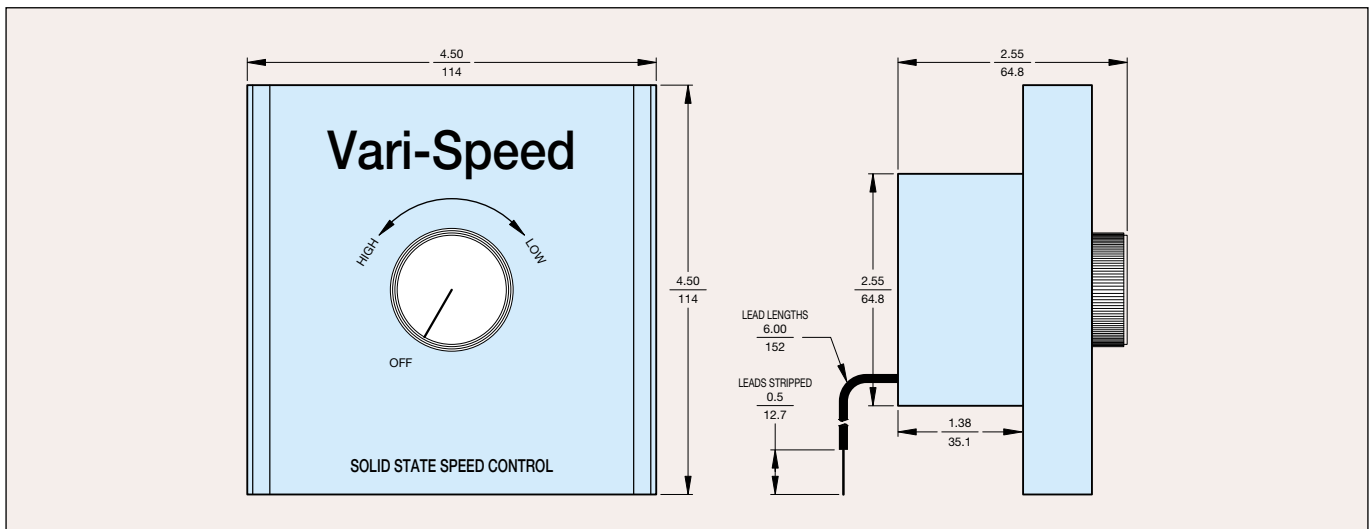

### APPLICATION NOTES

- 1. Radio Frequency Interference (RFI):** All solid-state speed controls generate annoying radio noise on the AM band. KB speed controls contain, as standard, a high-gain RFI suppression filter which significantly reduces this interference.
- 2. Low End Set Point (Minimum speed):** All 115 Volt input speed controls are factory set to 60 Volts AC output ( $\pm 3$  Volts), as standard. All 230 Volt input speed controls are factory set to 120 Volts AC output ( $\pm 6$  Volts), as standard. All controls are factory calibrated using an average responding AC voltmeter. Custom voltage settings are available.
- 3. Motor Suitability:** Motors must be loaded to near full capacity with the appropriate fan blade in order to achieve proper speed control. Generally, motor suitability is established by determining motor speed as a function of applied voltage. A motor is determined as suitable if it changes speed linearly over a wide range of voltage.  
**It is required that all motors contain a built-in thermal overload protector when used with solid-state speed controls.**
- 4. 230 & 277 VAC Controls:** To achieve maximum reliability, all 230 VAC controls contain snubber networks that utilize Y-Type capacitors and flame-proof resistors. In addition, all 277 VAC controls contain MOV Transient Suppression.
- 5. Temperature Test:** The non-sinusoidal output voltage of a solid-state speed control may increase motor heating. Therefore, it is necessary that a temperature test be performed to ensure that the motor is operating within manufacturer's specifications.
- 6. Leads:** All leads are approximately 6" (15 cm) long and stripped 1/2" (1.25 cm). Custom lead lengths, colors, and terminations also available.

### OTHER AC MOTOR SPEED CONTROLS



| RATINGS   |   |   |   |
|---|---|---|---|
| 2.5 Amps AC at<br>115 and 230 Volts AC 50/60 Hz   | 1.6 and 3 Amps at<br>115 and 230 Volts 50/60 Hz | 1.6, 2.5 and 4 Amps at<br>115 and 230 Volts AC 50/60 Hz | 300 Watts, 3 Amps AC at<br>125 Volts AC 50/60 Hz  |
| DESCRIPTION   |   |   |   |
| PANEL MOUNT: For ceiling fans, range hoods, vibrators, humidifiers, air conditioners, fireplace blowers, window fans, etc. Designed for Shaded Pole, AC/DC, and Permanent Split Capacitor Motors. |   |   | PLUG-IN: For incandescent lamps and wood-burning fireplaces and stove fans. Plugs into a standard 115 Volt AC outlet. |



**KB ELECTRONICS, INC.**

12095 NW 39th Street, Coral Springs, FL 33065-2516 • (954) 346-4900 • Fax (954) 346-3377  
 Outside Florida Call **Toll Free** (800) 221-6570 • **email** – info@kbelectronics.com  
 www.kbelectronics.com