

# 7 Pushbuttons and selector switches

PLatinum series dimensions [mm (in)]

## Selector switch actuators

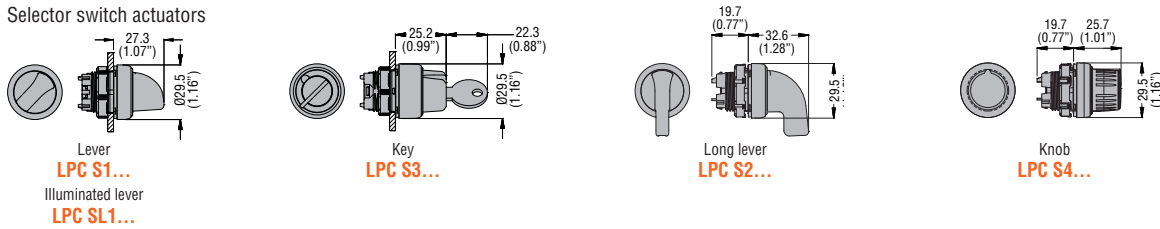

## Flush double-touch buttons with or without light indicator

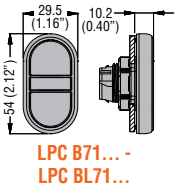

## Double-touch buttons with an extended button with or without light indicator

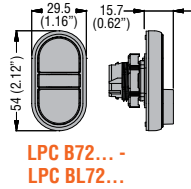

## Triple-touch button with middle extended button

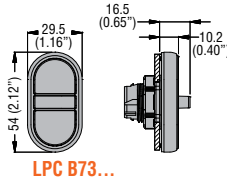

## Drillings - Minimum recommended distances

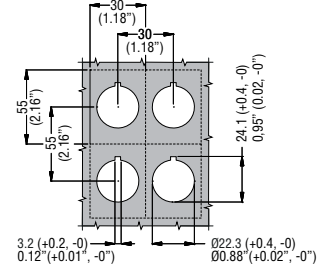

## Pilot light head

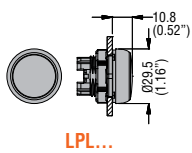

## LED-integrated monoblock pilot lights

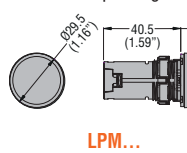

## Monoblock buzzers

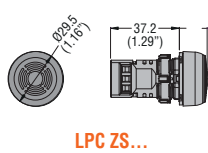

## Monoblock potentiometer

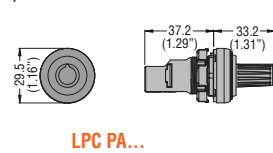

## Communication interfaces LPC D...

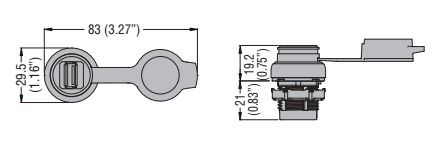

## Threaded plug for unused drilled holes

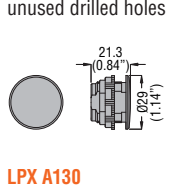

## Knob selector switch protection



## Label holder

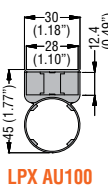

## Label

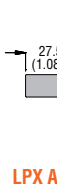

## Label holder

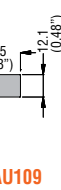

## Label



## Plastic disk for mushroom-head pushbuttons

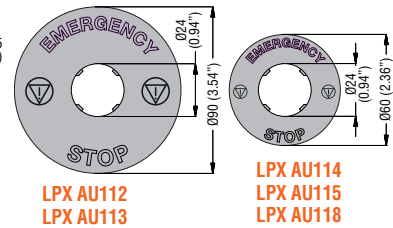

## Rubber boot for flush buttons

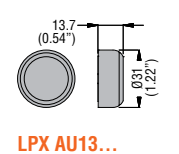

## Rubber boot for extended buttons

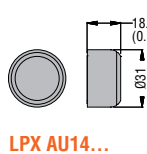

## Double/triple button boot

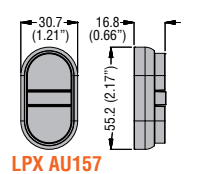

## Rubber boot for mushroom-head buttons

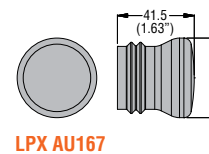

## Padlockable protection for mushroom-head latch buttons

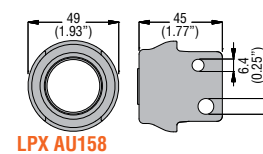

## Cable gland

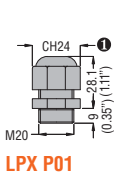

## Shroud for mushroom-head latch buttons

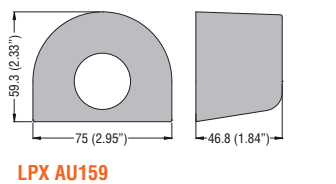

## DIN rail adapter

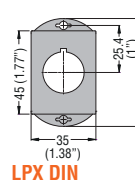

## CONTROL STATIONS WITHOUT ACTUATORS

### LPZ P1 A5... LPZ P1 A8...

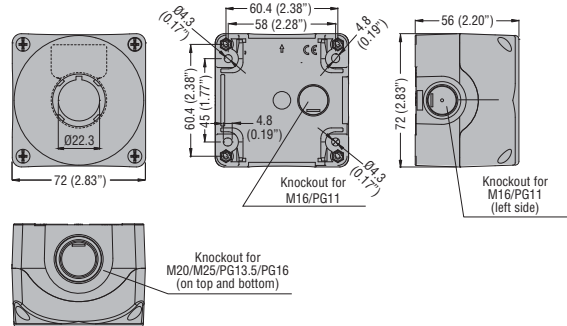

### LPZ P2 A5... LPZ P2 A8...

